

## 50, 40 & 30 W Programmable Constant Current LED Driver with Tri-Mode Dimming™ (TRIAC, ELV & 0-10 V)

Nominal Input Voltage	Max. Output Power	Efficiency	Max. Case Temperature	THD	Power Factor	Dimming Method	Dimming Range	Startup Time
120 to 277 Vac	50 W	up to 90% typical	90°C (measured at the hot spot)	< 20% (from 100% to 50% of max rated power)	> 0.9 (from 100% to 50% of max rated power)	Forward-Phase, Reverse-Phase & 0 - 10V	1 - 100% (% of Iout)	200 ms typical

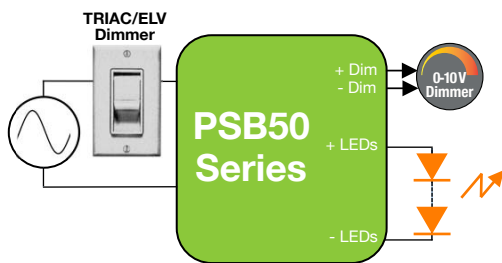

**Aluminum Case**  
 L 98.5 \* W 25.4 \* H 19.05 mm  
 (L 3.88 \* W 1.00 \* H 0.75 in.)

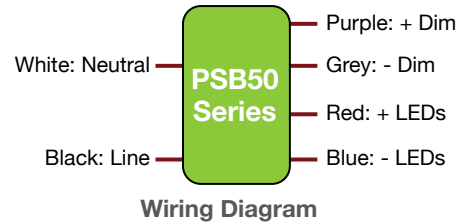

### FEATURES

- Non-linear 0-10V dimming profile with dim-to-off (10V to 9.1V=100%, 1.5V to 0.6V=1%, <0.6V=dim-to-off)
- UL Class P
- Class 2 power supply
- Lifetime: 50,000 hours @ Tc = 75°C
- 90°C maximum case hot spot temperature
- IP20-rated (IP64 as option) case with silicone-based potting
- Surge protection:
  - IEC61000-4-5: 2 kV line to line/2 kV line to earth
  - 2.5 kV ring wave: ANSI/IEEE c62.41.1-2002 & c62.41.2-2002 category A
- Complies with ENERGY STAR®, DLC (DesignLight Consortium®) and CA Title 24 technical requirements

### PROGRAMMING

- Serial port programming
  - Current: 100% to 50% in each voltage range
  - Data log read: SKU, S/N, lot code, hours of operation, FW rev., fault events: power failure, transients (short or surge), thermal

### OPTIONS

- Alternate 0-10V dimming profiles: Linear, Logarithmic, Ballast type Mark7 (IEC60929, ANSI C82.11)
- Energy metering (as part of future software upgrade)

### OTHER MOUNTING OPTIONS

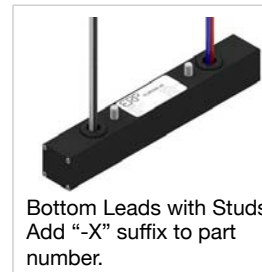

### APPLICATIONS

- Commercial & residential lighting
- Architectural lighting
- Indoor Lighting



## 50, 40 & 30 W Programmable Constant Current LED Driver with Tri-Mode Dimming™ (TRIAC, ELV & 0-10 V)

### 1 - ORDERING INFORMATION

Part Number	Nominal Input Voltage (Vac)	Max Output Power (W)	Iout (mA)	Vout Min. (Vdc)	Vout Nom. (Vdc)	Vout Max. (Vdc)	Open Loop (No Load) Voltage (Vdc)
<b>PSB30W</b>							
PSB30W-0700-42	120 to 277	29.4	350 to 700	27	37.8	42	50
PSB30W-1050-27	120 to 277	28.4	525 to 1050	17	24.3	27	35
PSB30W-0800-34	120 to 277	27.2	400 to 800	20	30.6	34	44.2
<b>PSB40W</b>							
PSB40W-1400-27	120 to 277	37.8	700 to 1400	17	24.3	27	35
<b>PSB50W</b>							
PSB50W-0550-85	120 to 277	46.8	275 to 550	54	76.5	85	100
PSB50W-0850-56	120 to 277	47.6	425 to 850	36	50.4	56	60
PSB50W-1200-42	120 to 277	50.4	600 to 1200	27	37.8	42	50
PSB50W-1400-34	120 to 277	47.6	700 to 1400	20	30.6	34	44.2

**Notes:**

- For each model, the default output current setting is the maximum current.
- To order the mounting option “Bottom Leads with Studs”, add the suffix “-X”. Example: PSB50W-1200-42-X
- To order the mounting option “Terminal Blocks”, add the suffix “-T”. Example: PSB50W-1200-42-T
- For additional options of output current and output voltage, contact your sales representative or send an email to: [SaveEnergy@erp-power.com](mailto:SaveEnergy@erp-power.com)
- Please order the programming cable using the part number “PROG-JACK-USB”.



## 50, 40 & 30 W Programmable Constant Current LED Driver with Tri-Mode Dimming™ (TRIAC, ELV & 0-10 V)

### 2 - INPUT SPECIFICATION (@25°C ambient temperature)

	Units	Minimum	Typical	Maximum	Notes
Input Voltage Range (Vin)	Vac	90	120, 230, 277	305	<ul style="list-style-type: none"> <li>The rated output current for each model is achieved at Vin≥108 Vac &amp; at Vin≥198 Vac</li> <li>At nominal load</li> </ul>
Input Frequency Range	Hz	47	50/60	63	
Input Current (Iin)	A			0.5 A @ 120 Vac 0.23 A @ 277 Vac	
Power Factor (PF)		0.9	> 0.9		<ul style="list-style-type: none"> <li>At nominal input voltage and with nominal LED voltage</li> <li>From 100% to 50% of rated power</li> </ul>
Inrush Current	A	Meets NEMA-410 requirements			<ul style="list-style-type: none"> <li>At any point on the sine wave and 25°C</li> <li>Active limiting inrush current is available as an option. Please contact your ERP representative or send an email to SaveEnergy@erp-power.com.</li> </ul>
Leakage Current	mA			0.3 mA @ 120 Vac 0.6 mA @ 230 Vac 0.7 mA @ 277 Vac	Measured per IEC60950-1
Input Harmonics	Complies with IEC61000-3-2 for Class C equipment				
Total Harmonics Distortion (THD)				20%	<ul style="list-style-type: none"> <li>At nominal input voltage and nominal LED voltage</li> <li>From 100% to 50% of rated power</li> <li>Complies with DLC (Design Light Consortium) technical requirements</li> </ul>
Efficiency	%	-	up to 90%	-	Measured with nominal input voltage, a full sinusoidal wave form and without dimmer attached.
Isolation	The AC input to the main DC output is isolated and meets Class II reinforced/double insulation power supply <input type="checkbox"/>				

### 3 - MAIN OUTPUT SPECIFICATION (@25°C ambient temperature)

	Units	Minimum	Typical	Maximum	Notes
Output Voltage (Vout)	Vdc				See ordering information for details
Output Current (Iout)	mA				<ul style="list-style-type: none"> <li>See ordering information for details</li> <li>The rated output current for each model is achieved at Vin≥108 Vac &amp; at Vin≥198 Vac.</li> </ul>
Output Current Regulation	%	-5	±2.5	5	<ul style="list-style-type: none"> <li>At nominal AC line voltage</li> <li>Includes load and current set point variations</li> </ul>
Output Current Overshoot	%	-	-	10	The driver does not operate outside of the regulation requirements for more than 500 ms during power on with nominal LED load and without dimmer.
Ripple Current	≤ 10% of rated output current for each model				<ul style="list-style-type: none"> <li>Measured at nominal LED voltage and nominal input voltage without dimming</li> <li>Calculated in accordance with the IES Lighting Handbook, 9th edition</li> </ul>
Dimming Range (% of Iout)	%	1		100	<ul style="list-style-type: none"> <li>The dimming range is dependent on each specific dimmer. It may not be able to achieve 1% dimming with some dimmers.</li> <li>Dimming performance is optimal when the driver is operated at its nominal output voltage matching the LED nominal Vf (forward voltage). Dimming performance may vary when the driver is operated near its minimum output voltage.</li> </ul>
Start-up Time	ms		200	500	<ul style="list-style-type: none"> <li>Without any dimmer attached, and at nominal input voltages and nominal load</li> <li>Measured from application of AC line voltage to 100% light output</li> <li>Complies with ENERGY STAR® luminaire specification and CA Title 24</li> </ul>
Isolation	The main DC output is certified and tested per UL8750 Class 2 or LED Class 2				

## 50, 40 & 30 W Programmable Constant Current LED Driver with Tri-Mode Dimming™ (TRIAC, ELV & 0-10 V)

### 4 - 0-10 V DIMMING CONTROL (@25°C ambient temperature)

	Units	Minimum	Typical	Maximum	Notes
<b>+Dim Signal, -Dim Signal</b>		The PSB50/40/30 series operate only with 0-10V dimmers that sink current. The method to dim the output current of the driver is done via the +Dim/-Dim Signal pins. The +Dim/-Dim signal pins can be used to adjust the output setting via a standard commercial wall dimmer, an external control voltage source (0 to 10 Vdc), or a variable resistor when using the recommended number of LEDs. The dimming input permits 1% to 100% dimming.			
<b>Dimming Profile (see figure 1)</b>		100% of output current between 10 V and 9.1 V, Linear between 9.1 V and 1.5 V, 1% of output current between 1.5 V and 0.6 V, No output current below 0.6 V.			
<b>Dimming Range</b>	%	1		100	As a percent of the output current
<b>High Level Voltage</b>	V		9.1		
<b>Low Level Voltage</b>	V		1.5		
<b>Dim to Off</b>	V		0.6		No output current
<b>Current Supplied by the +Dim Signal Pin</b>	mA			1	
<b>Output Current Tolerance While Being Dimmed</b>	%			±8	The tolerance of the output current while being dimmed is ≤ +/-8% until down to 1.5V.
<b>Isolation</b>	The 0-10 V circuit is isolated from the AC input and meets Class II reinforced/double insulation power supply. <input type="checkbox"/>				

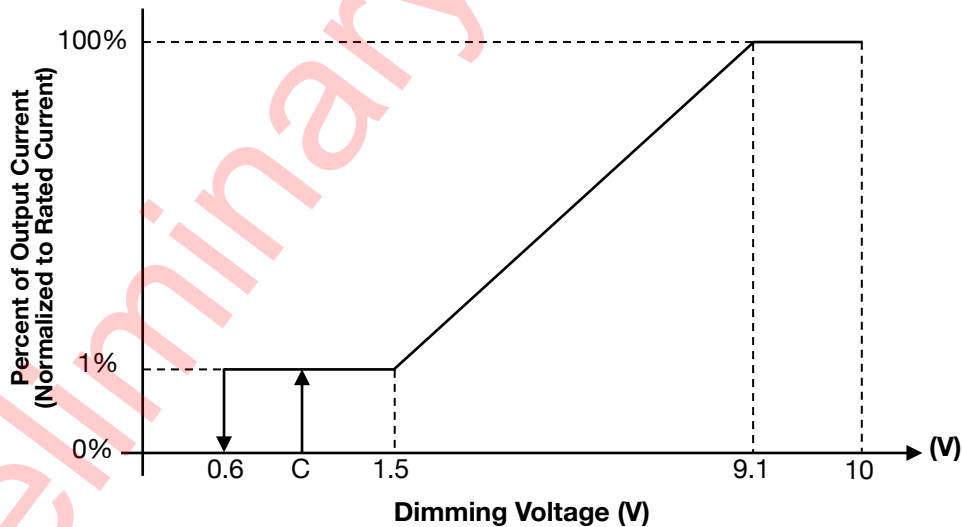

Dimming Voltage	Description	Value
C	hysteresis	> 700 mV, < 800 mV

**Figure 1**

## 50, 40 & 30 W Programmable Constant Current LED Driver with Tri-Mode Dimming™ (TRIAC, ELV & 0-10 V)

### 5 - ENVIRONMENTAL CONDITIONS

	Units	Minimum	Typical	Maximum	Notes
<b>Operating Ambient Temperature (Ta)</b>	°C	-20		50	50°C is the non-derated temperature (Refer to section 8 "Output power de-rating at higher temperatures").
<b>Maximum Case Temperature (Tc)</b>	°C			+90	Case temperature measured at the hot spot •tc (see label in page 11)
<b>Storage Temperature</b>	°C	-40		+85	
<b>Humidity</b>	%	5	-	95	Non-condensing
<b>Cooling</b>	Convection cooled				
<b>Acoustic Noise</b>	dBA			24	Measured at a distance of 1 meter, without dimmer
<b>Mechanical Shock Protection</b>	per EN60068-2-27				
<b>Vibration Protection</b>	per EN60068-2-6 & EN60068-2-64				
<b>MTBF</b>	> 200,000 hours when operated at nominal input and output conditions, and at Tc ≤ 75°C				
<b>Lifetime</b>	50,000 hours at Tc ≤ 75°C maximum case hot spot temperature (see hot spot •tc on label in page 11)				

### 6 - EMC COMPLIANCE AND SAFETY APPROVALS

EMC Compliance			
<b>Conducted and Radiated EMI</b>	<ul style="list-style-type: none"> <li>•Models with no suffix and with "-X" suffix: Compliant with FCC CFR Title 47 Part 15 Class B at 120 Vac &amp; Class A at 277 Vac</li> <li>•Models with "-T" suffix: Compliant with FCC CFR Title 47 Part 15 Class B at 120 Vac and Class A at 277 Vac and with EN55015 (CISPR 15) at 220, 230, and 240 Vac</li> </ul>		
<b>Harmonic Current Emissions</b>	IEC61000-3-2	For Class C equipment	
<b>Voltage Fluctuations &amp; Flicker</b>	IEC61000-3-3		
<b>Immunity Compliance</b>	<b>ESD (Electrostatic Discharge)</b>	IEC61000-4-2	6 kV contact discharge, 8 kV air discharge, level 3
	<b>RF Electromagnetic Field Susceptibility</b>	IEC61000-4-3	3 V/m, 80 - 1000 MHz, 80% modulated at a distance of 3 meters
	<b>Electrical Fast Transient</b>	IEC61000-4-4	± 2 kV on AC power port for 1 minute, ±1 kV on signal/control lines
	<b>Surge</b>	IEC61000-4-5	<ul style="list-style-type: none"> <li>•± 2 kV line to line (differential mode) /± 2 kV line to common mode ground (tested to secondary ground) on AC power port, ±0.5 kV for outdoor cables</li> <li>•Higher surge is available. Please contact your ERP representative or send an email to SaveEnergy@erp-power.com.</li> </ul>
			ANSI/IEEE c62.41.1-2002 & c62.41.2-2002 category A, 2.5 kV ring wave
	<b>Conducted RF Disturbances</b>	IEC61000-4-6	3V, 0.15-80 MHz, 80% modulated
	<b>Voltage Dips</b>	IEC61000-4-11	>95% dip, 0.5 period; 30% dip, 25 periods; 95% reduction, 250 periods

#### Safety Agency Approvals

<b>cUL</b>	UL8750 listed Class 2 (except PSB50W-0550-85)
<b>cUL</b>	CAN/CSA C22.2 No. 250.13-14 LED equipment for lighting applications
<b>CE</b>	IEC61347-2-13 electronic control gear for LED Modules & EN55015 (EMC compliance)
<b>CB</b>	
<b>ENEC</b>	

#### Safety

	Units	Minimum	Typical	Maximum	Notes
<b>Hi Pot (High Potential) or Dielectric voltage-withstand</b>	Vdc	2500			<ul style="list-style-type: none"> <li>•Insulation between the input (AC line and Neutral) and the output</li> <li>•Tested at the RMS voltage equivalent of 1767 Vac</li> </ul>

## 50, 40 & 30 W Programmable Constant Current LED Driver with Tri-Mode Dimming™ (TRIAC, ELV & 0-10 V)

### 7 - PROTECTION FEATURES

#### Short Circuit and Over Current Protection

The PSB50/40/30 series is protected against short-circuit such that a short from any output to return shall not result in a fire hazard or shock hazard. The driver shall hiccup as a result of a short circuit or over current fault. Removal of the fault will return the driver to within normal operation. The driver shall recover, with no damage, from a short across the output for an indefinite period of time.

#### Internal Over temperature Protection

The PSB50/40/30 series is equipped with internal temperature sensor on the primary power train. Failure to stay within the convection power rating will result in the power supply reducing the available current (fold back) below the programmed amount. The main output current will be restored to the programmed value when the temperature of the built-in temperature sensor cools adequately.

#### Output Open Load Protection

When the LED load is removed, the output voltage of the PSB50/40/30 series is typically limited to 1.3 times the maximum output voltage of each model.

### 8 - OUTPUT POWER DE-RATING AT ELEVATED TEMPERATURES

The PSB50/40/30 series can be operated with cooling air temperatures above 50°C by linearly de-rating the total maximum output power (or current) by 2.5%/°C from 50°C to 70°C (see figure 2).

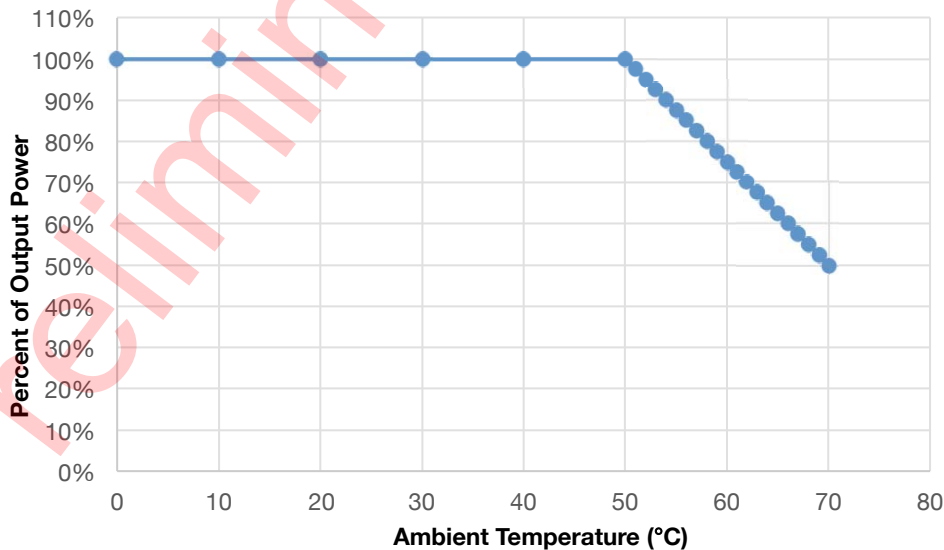

Figure 2

## 50, 40 & 30 W Programmable Constant Current LED Driver with Tri-Mode Dimming™ (TRIAC, ELV & 0-10 V)

### 9 - PHASE-CUT DIMMING

Dimming of the driver is possible with standard TRIAC-based incandescent dimmers that chop the AC voltage as shown in Figure 3, or with ELV dimmers. During the rapid rise time of the AC voltage when the dimmer turns on, the driver does not generate any voltage or current oscillations, and inrush current is controlled. During the on-time of the AC input, the driver regulates the output current based upon the conduction angle. The RMS value of the driver output current is proportional to the on-time of the AC input voltage. When operating with an incandescent dimmer, the RMS output current varies depending upon the conduction angle and RMS value of the applied AC input voltage. Figure 4 shows the typical output current versus conduction angle at nominal input voltage.

Forward-phase (TRIAC) and reverse-phase (ELV) dimming work only at 120 Vac.

The PSB50/40/30 series offers Tri-Mode Dimming™ compatibility with both phase-cut (reverse-phase and forward-phase) and 0–10V dimmers. Phase-cut dimming always has priority over 0-10 V dimming.

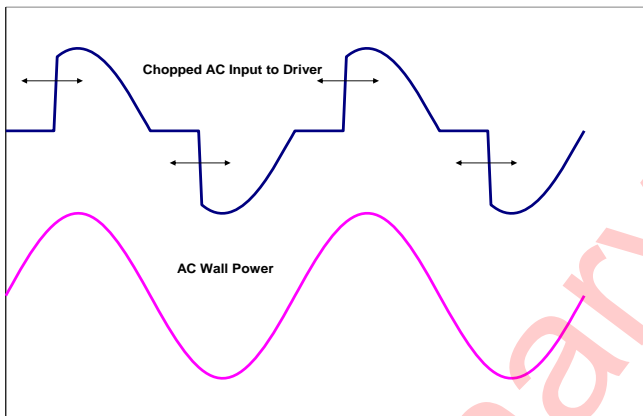

Figure 3

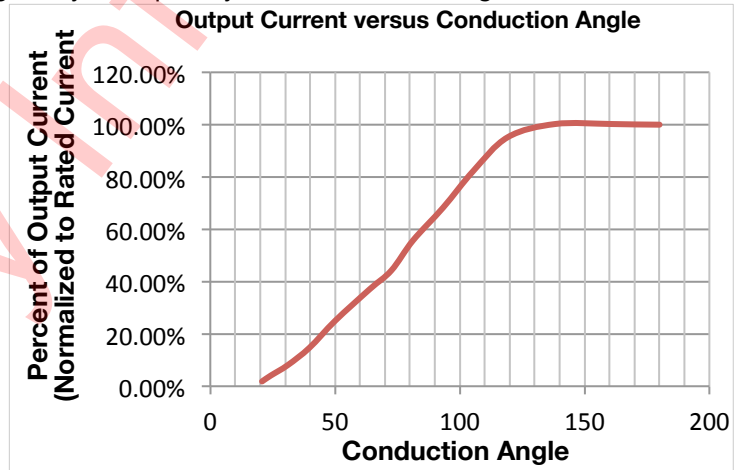

Figure 4

### 10 - COMPATIBLE PHASE-CUT DIMMERS & DIMMING RANGE

120Vac Dimmers					
Mfg.	Model	Mfg.	Model	Mfg.	Model
Lutron	S-603PG	Lutron	DVELV-303P	Lutron	CT-103P
Leviton	IPI06-1LZ	Lutron	SELV-300P	Cooper	SLC03P
Leviton	6631-2	Leviton	6683-IW	Leviton	IPE04
Lutron	DVCL-153P	Leviton	6161	Lutron	MAELV-600
Lutron	DV-600P	Leviton	6633-P	Lutron	FAELV-500
Lutron	TGCL-153P	Lutron	TG-600P	Lightolier	ZP260QEW
Lutron	S-600P	Cooper	DLC03P	Cooper	DAL06P
Leviton	VPE06	Lutron	LG-600P		

Dimming compatibility charts are available for each model in the PSB50/40/30 series. Please contact your sales representative or send an email to: [SaveEnergy@erp-power.com](mailto:SaveEnergy@erp-power.com).

## 50, 40 & 30 W Programmable Constant Current LED Driver with Tri-Mode Dimming™ (TRIAC, ELV & 0-10 V)

### 11 - 0-10 V DIMMING

The PSB50/40/30 series operate only with 0-10V dimmers that sink current. They are not designed to operate with 0-10V control systems that source current, as used in theatrical/entertainment systems. Developed in the 1980's, the 0-10V sinking current control method is adopted by the International Electrotechnical Commission (IEC) as part of its IEC Standard 60929 Annex E.

The method to dim the output current of the driver is done via the +Dim/-Dim Signal pins. The +Dim/-Dim Signal pins respond to a 0 to 10 V signal, delivering 1% to 100% of the output current based on rated current for each model. A pull-up resistor is included internal to the driver. When the +Dim wire (purple) is short circuited to the -Dim wire (grey) or to the -LED wire (blue), the output current turns off.

If the +Dim input is > 10 V or open circuited, the output current is programmed to 100% of the rated current.

When not used, the -Dim wire (grey) and to the +Dim wire (purple) can be individually capped or cut off. In this configuration, no dimming is possible and the driver delivers 100% of its rated output current.

The maximum source current (flowing from the driver to the 0-10V dimmer) supplied by the +Dim Signal pin is  $\leq 1$  mA. The tolerance of the output current while being dimmed shall be  $\pm 8\%$  typical until down to 1.5 V.

The non-linear 0-10V dimming profile is the default profile across all models of the PSB50/40/30 series. In the non-linear 0-10V dimming profile, shown in figure 5, 10V to 9.1V=100% of the output current, 1.5V to 0.6V=1%, <0.6V=dim-to-off (no output current). The non-linear curve is recommended when using standard in wall 0-10 V logarithmic dimmers to avoid having insufficient source current available to pull the dimmer up to 10V and to account for the inability of the dimmer to pull below approximately 0.9V. In these type of installations, the modified transfer function will ensure 100% light output and dimming to 1%, regardless of the number of drivers on the 0-10V dimming line. Please contact your sales representative or send an email to: [SaveEnergy@erp-power.com](mailto:SaveEnergy@erp-power.com) for additional information.

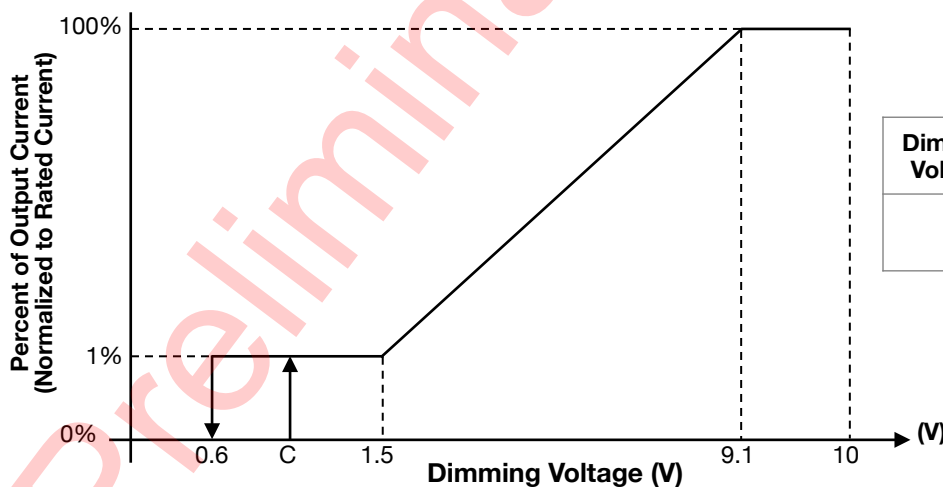

Figure 5

### 12 - COMPATIBLE 0-10 V DIMMERS

- Lutron, Nova series (part number NFTV)
- Lutron, Diva series (part number DVTV)
- Leviton, IllumaTech series (part number IP710-DL)



## 50, 40 & 30 W Programmable Constant Current LED Driver with Tri-Mode Dimming™ (TRIAC, ELV & 0-10 V)

### 13 - PROGRAMMING

The PSB50/40/30 series can be programmed by inserting the audio jack of the cable shown in figure 6 into the driver and by plugging the USB other end of the cable into a computer. **The driver does not need to be powered on during the programming process.**

When ordering the PSB50/40/30 series, please make sure you order a programming cable. The part number for the programming cable is “PROG-JACK-USB”.

Programming is done by using the ERP GUI (Graphical User Interface) which enables to trim or adjust output current from 100% to 50%.

Furthermore, when connecting the driver to a computer using the programming cable, you can access the driver’s internal data log and read the following information: SKU, serial number, manufacturing lot code, hours of operation, firmware revision, and fault events: power failure, transients (short or surge), thermal events (i.e. number of times the case temperature has exceeded the maximum case temperature of 90°C).

For more information, please refer to the GUI user’s manual.



Figure 6

## 50, 40 & 30 W Programmable Constant Current LED Driver with Tri-Mode Dimming™ (TRIAC, ELV & 0-10 V)

### 14 - MECHANICAL DETAILS

- Packaging Options:** Aluminum case
- I/O Connections:** Flying leads, 18 AWG on power leads, 22 AWG on 0-10V dimming wires and on auxiliary output, 203mm (8 in) long, 105°C rated, stranded, stripped by approximately 9.5mm, and tinned. All the wires, on both input and output, have a 600 V insulation rating.
- Ingress Protection:** IP20 rated
- Mounting Instructions:** The PSB50/40/30 driver case must be secured on a flat surface through the two mounting tabs, shown here below in the case outline drawings.

### 15 - OUTLINE DRAWINGS

- Dimensions:** L 98.5 \* W 25.4 \* H 19.05 mm (L 3.88 \* W 1.00 \* H 0.75 in.)
- Volume:** 46.9 cm<sup>3</sup> (2.87 in<sup>3</sup>)
- Weight:**

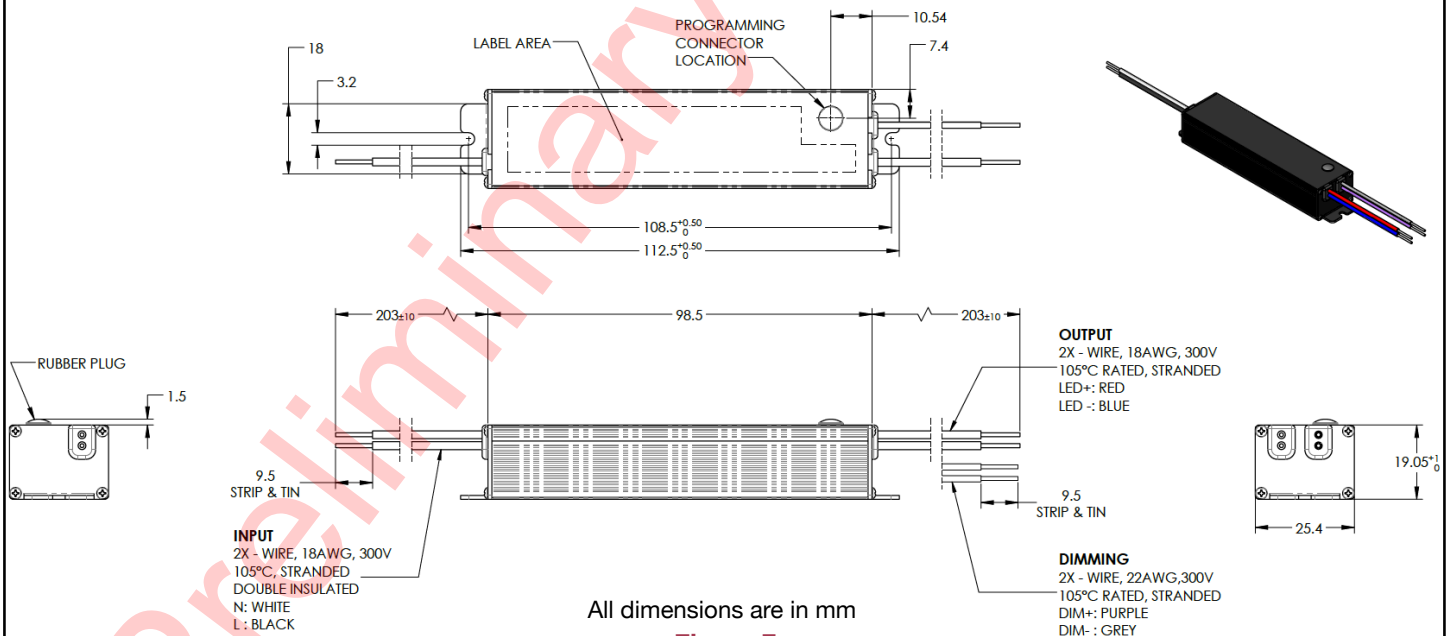

**Figure 7**



# PSB50/40/30 Series

**PSB50** 50 W  
**PSB40** 40 W  
**PSB30** 30 W

## 50, 40 & 30 W Programmable Constant Current LED Driver with Tri-Mode Dimming™ (TRIAC, ELV & 0-10 V)

### 16 - LABELING

The PSB50-1200-42 is used in figure 8 as an example to illustrate a typical label.

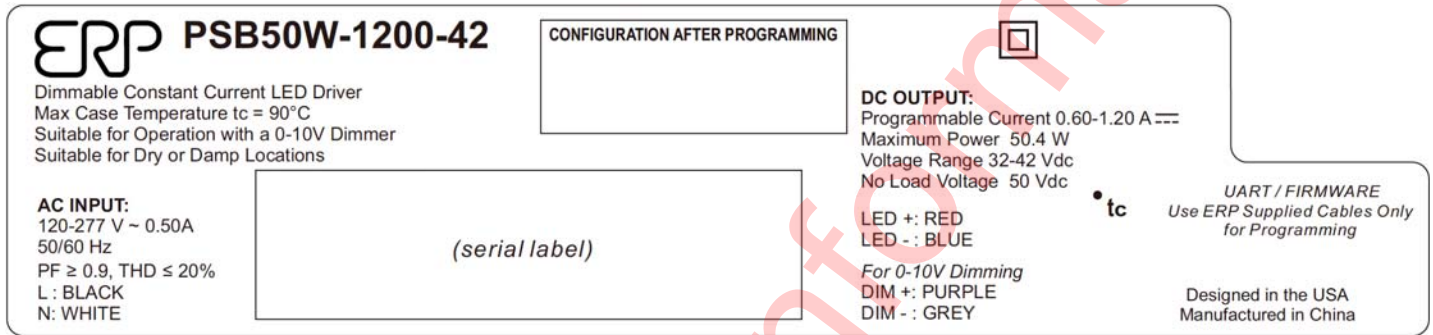

Figure 8

**USA Headquarters**  
 Tel: +1-805-517-1300  
 Fax: +1-805-517-1411  
 893 Patriot Drive, Suite E,  
 Moorpark, CA 93021, USA

**CHINA Operations**  
 Tel: +86-756-6266298  
 Fax: +86-756-6266299  
 No. 8 Pingdong Road 2  
 Zhuhai, Guangdong, China 519060

ERP Power, LLC (ERP) reserves the right to make changes without further notice to any products herein. ERP makes no warranty, representation or guarantee regarding the suitability of its products for any particular purpose, nor does ERP assume any liability arising out of the application or use of any product or circuit, and specifically disclaims any and all liability, including without limitation special, consequential or incidental damages. "Typical" parameters which may be provided in ERP data sheets and/or specifications can and do vary in different applications and actual performance may vary over time. All operating parameters, including "Typicals" must be validated for each customer application by customer's technical experts. ERP does not convey any license under its patent rights nor the rights of others. ERP products are not designed, intended, or authorized for use as components in systems intended for surgical implant into the body, or other applications intended to support or sustain life, or for any other application in which the failure of the ERP product could create a situation where personal injury or death may occur. Should Buyer purchase or use ERP products for any such unintended or unauthorized application, Buyer shall indemnify and hold ERP and its officers, employees, subsidiaries, affiliates, and distributors harmless against all claims, costs, damages, and expenses, and reasonable attorney fees arising out of, directly or indirectly, any claim of personal injury or death associated with such unintended or unauthorized use, even if such claim alleges that ERP was negligent regarding the design or manufacture of the part. ERP is an Equal Opportunity/Affirmative Action Employer. This literature is subject to all applicable copyright laws and is not for resale in any manner.

**50, 40 & 30 W Programmable Constant Current LED Driver  
with Tri-Mode Dimming™ (TRIAC, ELV & 0-10 V)**

**Revision History**

Revision	Date	Originator	Comments
Prelim.	15OCT2017	LJ	Created data sheet
Prelim.	02NOV2017	LJ	<ul style="list-style-type: none"> <li>• Updated feature table on front page.</li> <li>• Updated Lifetime: 50,000 hours @ Tc = 75°C</li> <li>• Updated part numbers in section 1 and added nominal values</li> <li>• Updated package dimensions and mechanical outline dimensions in section 15</li> <li>• Added a comment about the programming cable in section 1</li> <li>• Updated the 0-10V dimming profile in section 4 &amp; 11</li> <li>• Updated Safety agency approvals in section 6</li> </ul>
Prelim.	05NOV2017	LJ	<ul style="list-style-type: none"> <li>• Updated list of applications</li> </ul>
Prelim.	06NOV2017	LJ	<ul style="list-style-type: none"> <li>• Updated acoustic noise specification</li> </ul>
Prelim.	14NOV2017	LJ	<ul style="list-style-type: none"> <li>• Extended Vout range on all models</li> </ul>
Prelim.	25NOV2017	LJ	<ul style="list-style-type: none"> <li>• Combined the 2 Surge specs in section 6</li> </ul>
Prelim.	04DEC2017	LJ	<ul style="list-style-type: none"> <li>• Corrected the part number of the programming cable to "PROG-JACK-USB"</li> </ul>